

MONTAGEANLEITUNG ASSEMBLY INSTRUCTION

“Profi”



ART.-NR. 500 661 (Hochdeichsel)
ART.-NR. 500 662 (Tiefdeichsel)



ROLAND WERK GmbH

Industriestraße 16

49681 Garrel

Tel.: 0 44 74 / 94 83-0

Fax: 0 44 74 / 94 83-33

www.roland-werk.de

MONTAGEANLEITUNG ASSEMBLY INSTRUCTION

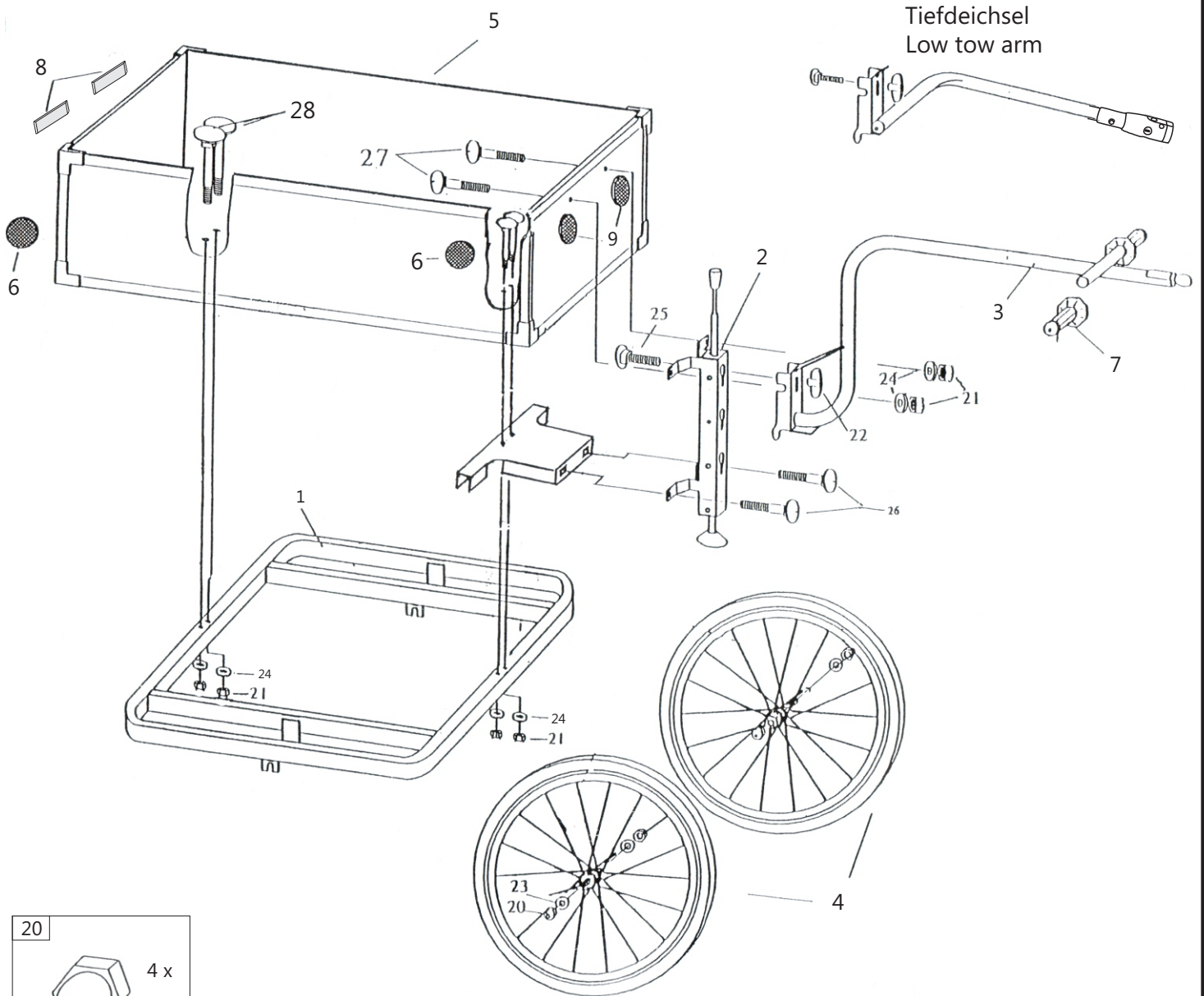



Tiefdeichsel
Low tow arm

20		4 x
Achsmutter Axle nut		

21		8 x
Mutter Nut M6		

22		1 x
Flügelmutter Wing nut M8		

23		4 x
Scheibe Washer \varnothing 10.5		

24		8 x
Scheibe Washer \varnothing 6.4		

25		1 x
Schraube Screw M8 x 25		

26		2 x
Schraube Screw M6 x 16		

27		2 x
Schraube Screw M6 x 20		

28		4 x
Schraube Screw M6 x 35		

Nr. No.	Beschreibung Description	Stck Pcs
1	Rahmen Frame	1
2	Deichselaufnahme Tow arm adapter	1
3	Deichsel Tow arm	1
4	Laufräder Wheels	2
5	Kasten Box	1
6	Reflektoren gelb Reflectors yellow	4
7	Kunststoffgriffe Plastic handle bars	2
8	Z-Reflektoren rot Z-Reflectors red	2
9	Reflektoren weiß Reflector white	2