

# MONTAGEANLEITUNG ASSEMBLY INSTRUCTION

## “Jumbo”



ART.-NR. 500 664 (Hochdeichsel)  
ART.-NR. 500 665 (Tiefdeichsel)



ROLAND WERK GmbH

Industriestraße 16  
49681 Garrel  
Tel.: 0 44 74 / 94 83-0  
Fax: 0 44 74 / 94 83-33

[www.roland-werk.de](http://www.roland-werk.de)

# MONTAGEANLEITUNG ASSEMBLY INSTRUCTION

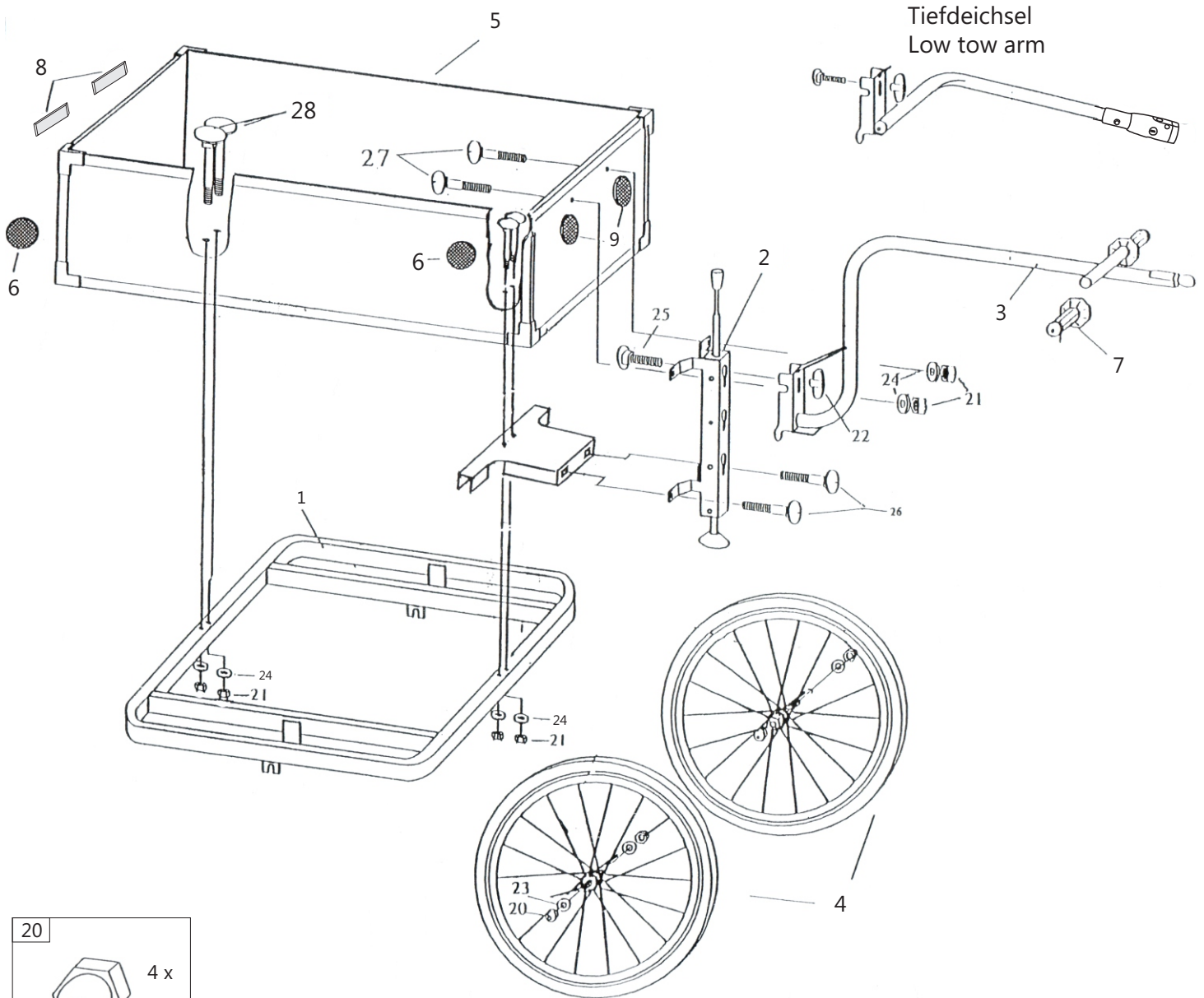



Tiefdeichsel  
Low tow arm

20		4 x
	Achsmutter Axle nut	

21		8 x
	Mutter Nut	M6

22		1 x
	Flügelmutter Wing nut	M8

23		4 x
	Scheibe Washer	∅ 10.5

24		8 x
	Scheibe Washer	∅ 6.4

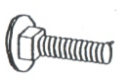
25		1 x
	Schraube Screw	M8 x 25

26		2 x
	Schraube Screw	M6 x 16

27		2 x
	Schraube Screw	M6 x 20

28		4 x
	Schraube Screw	M6 x 45

Nr. No.	Beschreibung Description	Stck Pcs
1	Rahmen Frame	1
2	Deichselaufnahme Tow arm adapter	1
3	Deichsel Tow arm	1
4	Laufräder Wheels	2
5	Kasten Box	1
6	Reflektoren gelb Reflectors yellow	4
7	Kunststoffgriffe Plastic handle bars	2
8	Z-Reflektoren rot Z-Reflectors red	2
9	Reflektoren weiß Reflector white	2